

5080A/SC

Oscilloscope Calibration Option

Users Manual

LIMITED WARRANTY AND LIMITATION OF LIABILITY

Each Fluke product is warranted to be free from defects in material and workmanship under normal use and service. The warranty period is one year and begins on the date of shipment. Parts, product repairs, and services are warranted for 90 days. This warranty extends only to the original buyer or end-user customer of a Fluke authorized reseller, and does not apply to fuses, disposable batteries, or to any product which, in Fluke's opinion, has been misused, altered, neglected, contaminated, or damaged by accident or abnormal conditions of operation or handling. Fluke warrants that software will operate substantially in accordance with its functional specifications for 90 days and that it has been properly recorded on non-defective media. Fluke does not warrant that software will be error free or operate without interruption.

Fluke authorized resellers shall extend this warranty on new and unused products to end-user customers only but have no authority to extend a greater or different warranty on behalf of Fluke. Warranty support is available only if product is purchased through a Fluke authorized sales outlet or Buyer has paid the applicable international price. Fluke reserves the right to invoice Buyer for importation costs of repair/replacement parts when product purchased in one country is submitted for repair in another country.

Fluke's warranty obligation is limited, at Fluke's option, to refund of the purchase price, free of charge repair, or replacement of a defective product which is returned to a Fluke authorized service center within the warranty period.

To obtain warranty service, contact your nearest Fluke authorized service center to obtain return authorization information, then send the product to that service center, with a description of the difficulty, postage and insurance prepaid (FOB Destination). Fluke assumes no risk for damage in transit. Following warranty repair, the product will be returned to Buyer, transportation prepaid (FOB Destination). If Fluke determines that failure was caused by neglect, misuse, contamination, alteration, accident, or abnormal condition of operation or handling, including overvoltage failures caused by use outside the product's specified rating, or normal wear and tear of mechanical components, Fluke will provide an estimate of repair costs and obtain authorization before commencing the work. Following repair, the product will be returned to the Buyer transportation prepaid and the Buyer will be billed for the repair and return transportation charges (FOB Shipping Point).

THIS WARRANTY IS BUYER'S SOLE AND EXCLUSIVE REMEDY AND IS IN LIEU OF ALL OTHER WARRANTIES, EXPRESS OR IMPLIED, INCLUDING BUT NOT LIMITED TO ANY IMPLIED WARRANTY OF MERCHANTABILITY OR FITNESS FOR A PARTICULAR PURPOSE. FLUKE SHALL NOT BE LIABLE FOR ANY SPECIAL, INDIRECT, INCIDENTAL, OR CONSEQUENTIAL DAMAGES OR LOSSES, INCLUDING LOSS OF DATA, ARISING FROM ANY CAUSE OR THEORY.

Since some countries or states do not allow limitation of the term of an implied warranty, or exclusion or limitation of incidental or consequential damages, the limitations and exclusions of this warranty may not apply to every buyer. If any provision of this Warranty is held invalid or unenforceable by a court or other decision-maker of competent jurisdiction, such holding will not affect the validity or enforceability of any other provision.

Fluke Corporation
P.O. Box 9090
Everett, WA 98206-9090
U.S.A.

Fluke Europe B.V.
P.O. Box 1186
5602 BD Eindhoven
The Netherlands

Table of Contents

Title	Page
Introduction.....	1
Oscilloscope Calibration Option Specifications	1
General Specifications	2
Detailed Specifications	2
Voltage Function	2
Edge Function.....	3
Leveled Sine Wave Function.....	3
Time Marker Function.....	3
Trigger Signal for the Time Marker Function	4
Trigger Signal for the Edge Function	4
Oscilloscope Connections.....	4
Starting the Oscilloscope Calibration Option	4
The Output Signal.....	5
Adjusting the Output Signal	5
Keying in a Value.....	5
Adjusting Values with the Rotary Knob	6
Using the $\times 10$ and $\div 10$	6
Resetting the Oscilloscope Option	6
Calibrating the Voltage Amplitude on an Oscilloscope.....	7
The Volt Function.....	7
The V/DIV Menu	7
Shortcuts for Setting the Voltage Amplitude	8
Amplitude Calibration Procedure for an Oscilloscope	8
Calibrating the Pulse and Frequency Response on an Oscilloscope.....	9
The Edge Function	10
Pulse Response Calibration Procedure for an Oscilloscope.....	10
The Leveled Sine Wave Function	11
Shortcuts for Setting the Frequency and Voltage	12
The MORE Options Menu	12
Sweeping through a Frequency Range	14
Frequency Response Calibration Procedure for an Oscilloscope.....	14
Calibrating the Time Base of an Oscilloscope.....	16
The Time Marker Function	16
Time Base Marker Calibration Procedure for an Oscilloscope	17
Summary of Commands and Queries	18
Verification Tables	20

List of Tables

Table	Title	Page
1.	Shape Marker Periods	17
2.	Overlapped and Coupled Commands.....	19
3.	Voltage Function Verification: AC Voltage into a 1 M Ω ohm Load.....	20
4.	Voltage Function Verification: AC Voltage into a 50 Ω Load	21
5.	Voltage Function Verification: DC Voltage into a 50 Ω Load	22
6.	Voltage Function Verification: DC Voltage into a 1 M Ω Load.....	22
7.	Edge Function Verification	23
8.	Leveled Sine Wave Function Verification: Amplitude.....	23
9.	Leveled Sine Wave Function Verification: Flatness	24
10.	Leveled Sine Wave Function Verification: Frequency	27
11.	Marker Generator Function Verification.....	27

List of Figures

Figure	Title	Page
1.	Oscilloscope Connection: Channel and External Trigger	4

Introduction

The Oscilloscope Calibration Option provides functions that help you maintain your oscilloscope's accuracy by verifying the following oscilloscope characteristics:

- Vertical deflection characteristics are verified by calibrating the voltage gain. The Volt function lets you compare the voltage gain to the graticule lines on the oscilloscope.
- Pulse response is checked using the Edge function, by verifying the accuracy of the oscilloscope's measurement of pulse transitions.
- Frequency response is checked by verifying the bandwidth using the Leveled Sine Wave function. A leveled sine wave is monitored until the -3 dB point is observed on the oscilloscope.
- Horizontal deflection characteristics are verified by calibrating the time base using the Time Marker function. This calibration procedure is similar to the one for verifying the vertical deflection characteristics, except that it checks the horizontal axis.

The menus that implement these functions also include parameters for altering the way the output signal responds to voltage, frequency, and time settings, giving you control of the signal during calibration, and providing more methods for observing the signal's characteristics.

Oscilloscope Calibration Option Specifications

These specifications apply only to the Oscilloscope Calibration Option. General specifications that apply to the 5080A Calibrator can be found in Chapter 1 of the *5080A Operators Manual*. The specifications are valid providing the 5080A is operated under the conditions specified in Chapter 1 of the *5080A Operators Manual*, and has completed a warm-up period of at least twice the length of time the calibrator was powered off, up to a maximum of 30 minutes.

General Specifications

All specifications are valid after a warm-up period of 30 minutes, or twice the time since last warmed up, to a maximum of 30 minutes. For example, if the 5080A has been turned off for 5 minutes, the warm-up period is 10 minutes.

Specifications include stability, temperature coefficient, linearity, line and local regulation, and the traceability of the external standards used for calibration. It is not necessary to add anything to determine the total specification for the temperature range indicated.

Specification Confidence Level..... 99 %

Warmup Time Twice the time since last warmed up, to a maximum of 30 minutes.

Temperature

Operating 0 °C to 50 °C

Calibration (tcal)..... 15 °C to 35 °C

Storage -20 °C to +70 °C

Temperature Coefficient..... Temperature coefficient for temperatures outside tcal ± 5 °C is 10 % of the stated specification per °C for temperatures in the range of 0 °C to 35 °C. Above 35 °C, the temperature coefficient is 20 % of the stated specification per °C.

Relative Humidity

Operating <80 % to 30 °C, <70 % to 40 °C, <40 % to 50 °C.

Storage <95 %, non-condensing

Altitude

Operating 2,000 m (6,500 ft) maximum

Non-operating 12,200 m (40,000 ft) maximum

Detailed Specifications

Voltage Function

Voltage Function	DC Signal		Square Wave Signal	
	Into 50 Ω	Into 1 M Ω	Into 50 Ω	Into 1 M Ω
Amplitude Characteristics				
Range	0 V to ± 2.2 V	0 V to ± 33 V	1.8 mV to 2.2 V p-p	1.8 mV to 105 V p-p ^[1]
Resolution	<100 V: 4 digits or 10 μ V, whichever is greater ≥ 100 V: 5 digits			
Adjustment Range	Continuous ^[1]			
Specification, 1-Year, tcal ± 5 °C	$\pm(0.35$ % of output +200 μ V) ^[2] ^[3]			
Sequence	1-2-5 (e.g., 10 mV, 20 mV, 50 mV)			
Square Wave Frequency Characteristics				
Range	45 Hz to 1 kHz			
Specification, 1-Year, tcal ± 5 °C	$\pm(50$ ppm of setting +25 mHz)			
Typical Aberration within 30 μ s from leading edge	<(3 % of output +200 μ V)			
<p>[1] The square wave into 1 MΩ is a positive square wave from 1.8 mV to 55 V p-p. From 95 V to 105 V. Its output is a square wave-like signal that alternates between the negative peak and the positive peak, with the centerline at -10 V. Signals between 55 V and 95 V p-p are not available.</p> <p>[2] The uncertainty of 50 Ω loads does not include the input impedance error of the oscilloscope. Square wave signals below 4.5 mV p-p have a specification of $\pm(0.35$ % of output +300 μV).</p> <p>[3] Signals from 95 to 105 V p-p have a specification of 1 % of output in the frequency range 100 Hz to 1 kHz. Typical specification is 3 % of output for 95 V to 105 V p-p signals in the frequency range 45 Hz to 100 Hz.</p>				

Edge Function

Edge Characteristics into 50 Ω		Specification, 1-Year, tcal ±5 °C
Amplitude		
Range	4.5 mV to 2.75 V	±(2 % of output +300 μV)
Resolution	4 digits	
Adjustment Range	±10 % around each sequence value (indicated below)	
Sequence	5 mV, 10 mV, 25 mV, 50 mV, 100 mV, 250 mV, 500 mV, 1 V, 2.5 V	
Other Edge Characteristics		
Frequency Range	900 Hz to 1.1 MHz	±(5 ppm of setting +15 mHz)
Rise Time	<1 ns	
Leading Edge Aberrations	Within 10 ns	<(3 % of output +3 mV)
	10 to 30 ns	<(1 % of output +3 mV)
	After 30 ns	<(0.5 % of output +3 mV)
Typical Duty Cycle	45 % to 55 %	

Leveled Sine Wave Function

Leveled Sine Wave Characteristics into 50 Ω	Frequency Range		
	50 kHz Reference	50 kHz to 100 MHz	100 to 200 MHz ^[1]
Amplitude Characteristics			
Range (p-p)	5 mV to 5.5 V		
Resolution	<100 mV: 3 digits ≥100 mV: 4 digits		
Adjustment Range	Continuously adjustable		
Specification, 1-Year, tcal ±5 °C	±(2 % of output +300 μV)	±(3.5 % of output +400 μV)	±(4 % of output +400 μV)
Flatness (relative to 50 kHz)	Not applicable	±(1.5 % of output +200 μV)	±(2.0 % of output +200 μV)
Short-term Stability	≤1 % ^[1]		
Frequency Characteristics			
Resolution	10 Hz	10 kHz ^[2]	10 kHz
Specification, 1-Year, tcal ±5 °C	±5 ppm	±5 ppm	±5 ppm
Distortion Characteristics			
2 nd Harmonic	≤-33 dBc		
3 rd and higher Harmonics	≤-38 dBc		
^[1] Within one hour after reference amplitude setting, provided temperature varies no more than ±5 °C. ^[2] At frequencies below 120 kHz, the resolution is 10 Hz. For frequencies between 120 kHz and 999.9 kHz, the resolution is 100 Hz.			

Time Marker Function

Time Marker into 50 Ω	5 s to 50 ms	20 ms to 100 ns	50 ns to 20 ns	10 ns	5 ns to 2 ns
Specification at cardinal points, 1-Year, tcal ±5 °C ^[2]	±(50 + t*1500) ppm ^[1]	±5 ppm	±5 ppm	±5 ppm	±5 ppm
Wave Shape	spike or square	spike, square, or sq20%	spike or square	square or sine	sine
Typical Output Level	>1 V p-p	>1 V p-p	>1 V p-p	>1 V p-p	>1 V p-p
Sequence	5-2-1 from 5 s to 2 ns (e.g., 500 ms, 200 ms, 100 ms)				
Adjustment Range	At least ±10 % around each sequence value indicated above.				
Amplitude Resolution	4 digits				
^[1] t is the time in seconds. ^[2] Away from the cardinal points, add ±50 ppm.					

Trigger Signal for the Time Marker Function

Time Marker Period	Division Ratio	Amplitude into 50 Ω (p-p)	Typical Rise Time
5 to 35 ms	off, /1	≥1 V p-p	≤2 ns
34.99 ms to 750 ns	off, /1, /10, /100	≥1 V p-p	≤2 ns
749.9 to 10 ns	off, /10, /100	≥1 V p-p	≤2 ns
9.99 to 2 ns	off, /100	≥1 V p-p	≤2 ns

Trigger Signal for the Edge Function

Edge Signal Frequency	Division Ratio	Amplitude into 50 Ω (p-p)	Typical Rise Time
900 Hz to 1.1 MHz	off, /1	≥1 V p-p	≤2 ns

Oscilloscope Connections

Using the cable supplied with the Oscilloscope Calibration Option, attach the SCOPE connector on the 5080A to one of the channel connectors on your oscilloscope (see Figure 1).

To use the external trigger, attach the TRIG OUT connector on the 5080A to the external trigger connection on your oscilloscope. To use the external trigger and view its signal with the calibration signal, attach the TRIG OUT connector to another channel. See your oscilloscope manual for details on connecting and viewing an external trigger.

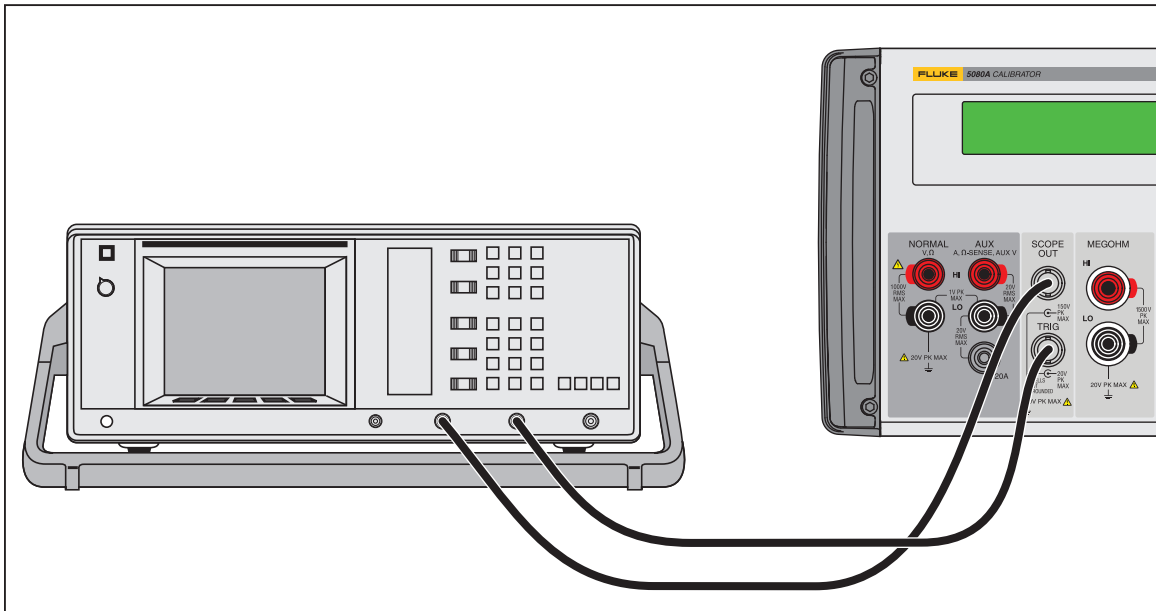

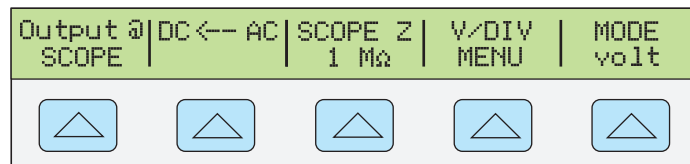

Figure 1. Oscilloscope Connection: Channel and External Trigger

gjm001.eps

Starting the Oscilloscope Calibration Option

Press  to start the Oscilloscope Calibration Option. The Control Display opens the Volt menu, shown below, which contains options for calibrating the vertical gain on your oscilloscope. This is the first of four calibration menus, which you can scroll through by pressing the softkey under MODE. Each menu is described in detail in this chapter.



gjm014.eps

The Output Signal

The location of the output signal is indicated on the Control Display (the display on the right side). If your 5080A is connected, but the output does not appear on the oscilloscope, you may have the 5080A in standby mode.

The settings for the output signal are indicated in the Output Display (the display on the left side). The following example shows the default settings for Volt mode, which are set when you start the Oscilloscope Calibration Option.



gjm002.eps





If STBY is displayed, press the  key. The Output Display will show OPR and the output should appear on the oscilloscope.

Adjusting the Output Signal

The 5080A provides several ways to change the settings for the output signal during calibration. Since oscilloscope calibration requires many adjustments of the output signal, the three available methods for changing these settings for oscilloscope calibration are summarized below. These methods provide the means of jumping to a new value or sweeping through a range of values.

Keying in a Value





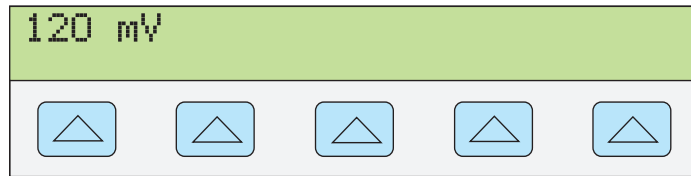



To key in a specific value directly into the 5080A from its front panel:

1. Key in the value you want to enter, including the units and prefixes. For example to enter 120 mV press     . The Control Display will show:



g1002i.eps

Note

Units and prefixes printed in purple in the upper left corner of the keys are accessed through the  key. For example, to enter 200 μ s in marker mode, push       .

If you make an error, press  to clear the Control Display and return to the menu.

2. Press  to activate the value and move it to the Output Display.

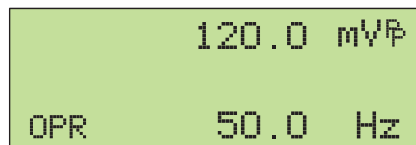

gjm010.eps

Other settings in the display will remain unaltered unless you key in an entry and specify the units for that setting.

Adjusting Values with the Rotary Knob

To adjust values in the Output Display using the rotary knob:

1. Turn the rotary knob. A cursor appears in the output display under the lowest digit and begins changing that digit. If you wish to place the cursor in the field without changing the digit, press **EDIT FIELD**.

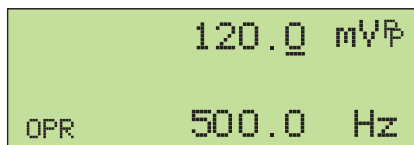

gjm011.eps

2. To move the cursor between the voltage and frequency fields, press **EDIT FIELD**.

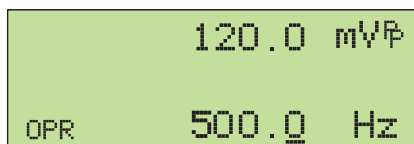

gl004i.eps

3. Use the **◀** and **▶** keys to move the cursor to the digit you want to change.
4. Turn the rotary knob to change the value.

When you use the rotary knob in either Volt mode or Marker mode, the Control Display shows the new value's percentage change from the reference value. This is useful for determining the percentage of error on the oscilloscope. You can set the reference value to the new value by pressing **NEW REF**.

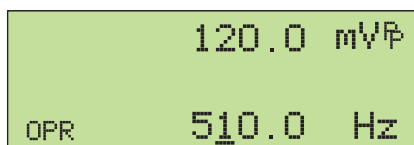

gjm013.eps

5. Press **ENTER** to remove the cursor from the Output Display and save the new value as the reference value.

Note

If you attempt to use the rotary knob to adjust a value to an amount that is invalid for the function you are using, or is outside the value's range limit, the value will not change and the 5080A will beep. If you need to reach a different range of values, turn the knob quickly to jump to the new range.

Using the **x10** and **+10**

The **x10** and **+10** keys cause the current value of the signal to jump to a pre-determined cardinal value, whose amount is determined by the current function. These keys are described in more detail under the descriptions for each function.

Resetting the Oscilloscope Option

You can reset all parameters in the 5080A to their default settings at any time during front panel operations by pressing the **RESET** key on the front panel.

After resetting the 5080A, press **SCOPE** to return to the Oscilloscope Calibration Option (the Volt menu appears). Press **OPR** to reconnect the signal output.

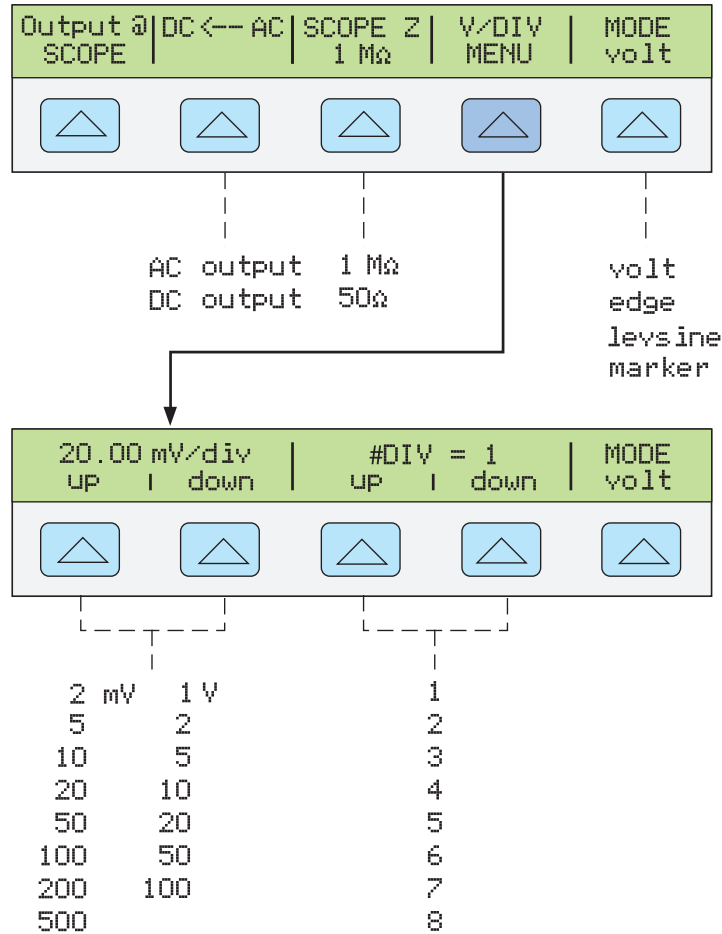

gjm004.eps

Each item in the V/DIV menu is described below.

- **V/div** Changes the scale of the output display by changing the number of volts that are represented by each division. The available settings, shown in the figure above, are provided in 1-2-5 step increments. Press the softkey under UP to increase the volts per division. Press the softkey under DOWN to decrease the volts per division.
- **# DIV** Specifies the number of divisions that establish the p-p value of the waveform. The value can be adjusted from one to eight divisions. The amount denoted by each division is displayed in the V/div field. Press the softkey under UP to increase the signal's height, and press the softkey under DOWN to decrease it.

Shortcuts for Setting the Voltage Amplitude

The $\times 10$ and $\div 10$ keys step the voltages through cardinal point values of an oscilloscope in a 1-2-5 step sequence. For example, if the voltage is 40 mV, then pressing $\times 10$ increases the voltage to the nearest cardinal point, which is 50 mV. Pressing $\div 10$ decreases the voltage to the nearest cardinal point, which is 20 mV.

Amplitude Calibration Procedure for an Oscilloscope

This example procedure describes how to use the Volt menu to calibrate the oscilloscope's amplitude gain. During calibration, you will need to set different voltages and verify that the gain matches the graticule lines on the oscilloscope according to the specifications for your particular oscilloscope. See your oscilloscope manual for the recommended calibration settings and appropriate gain values.







Before you start this procedure, verify that you are running the oscilloscope option in

Volt mode. If you are, the Control Display shows the following menu.



gjm015.eps

Perform the following sample procedure to calibrate the vertical gain.

1. Connect the calibrator to Channel 1 on the oscilloscope, making sure the oscilloscope is terminated at the proper impedance (1 MΩ for this example). Verify that the  key on the 5080A is lit, indicating that the signal is connected.
2. Key in the voltage level that is recommended for your oscilloscope. For example to enter 30 mV, press     then press . See “Keying in a Value” earlier in this chapter.
3. Adjust the oscilloscope as necessary. The waveform should be similar to the one shown below, with the gain at exactly the amount specified for the calibration settings for your oscilloscope.

This example shows the gain at 30 mV to be 6 divisions, at 5 mV per division.

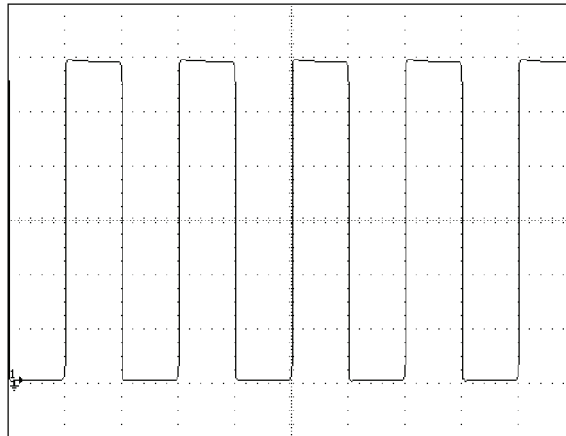

gl006i.bmp

4. Change the voltage to the next value recommended for calibrating your oscilloscope model, and repeat this procedure at the new voltage level, verifying the gain is correct according to the specifications in your manual.
5. Repeat the procedure for each channel.

Calibrating the Pulse and Frequency Response on an Oscilloscope

The pulse response is calibrated with a square-wave signal that has a fast leading edge rise-time. Using this signal, you adjust the oscilloscope as necessary until it meets its particular specifications for rise time and pulse aberrations.

Following pulse verification, the frequency response is checked by applying a leveled sine wave and acquiring a frequency reading at the -3 dB point, when the amplitude drops approximately 30 %.

The Edge Function

The Edge function is used for calibrating the pulse response for your oscilloscope. To reach the Edge menu, press the softkey under MODE until “edge” appears.

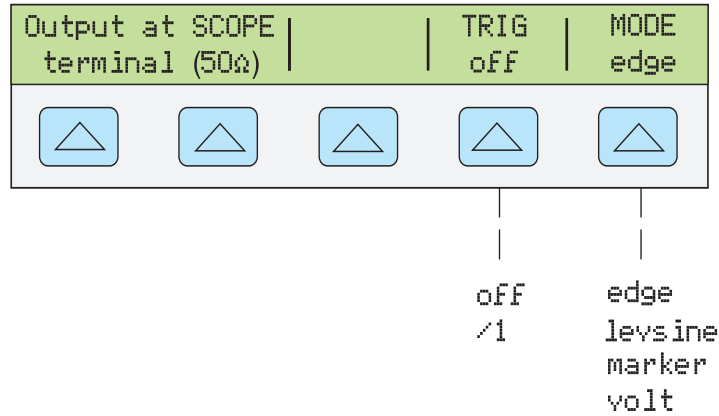

gjm005.eps

Each option in the Edge menu is described below.

- OUTPUT @ SCOPE terminal (50 Ω)** Indicates the location and impedance of the signal output. If the signal does not appear on the oscilloscope, press **OPR**. To disconnect the signal, press **STBY**.
 You cannot change the output impedance in Edge mode.
- TRIG** If you are using the external trigger, use this key to toggle the trigger off and on. When on, the reading will show “/1” which indicates that the external trigger is at the same frequency as the edge output.
 The external trigger can be useful for many digital storage oscilloscopes that have difficulty triggering on fast rise time signals.
- MODE** Indicates you are in Edge mode. Use the softkey to change modes and open the corresponding menus for the other three oscilloscope calibration modes.

Pulse Response Calibration Procedure for an Oscilloscope

This sample procedure shows how to check the oscilloscope’s pulse response. Before you check your oscilloscope, see your oscilloscope’s manual for the recommended calibration settings.

Before you start this procedure, verify that you are running the oscilloscope option in Edge mode. If you are, the Control Display shows the following menu.

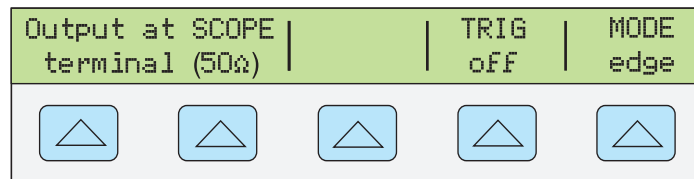

gl028i.eps

Perform the following sample procedure to calibrate the pulse response.

- Connect the 5080A to Channel 1 on the oscilloscope. Select 50 Ω impedance or use a 50 Ω termination directly at the oscilloscope input. Verify that the **OPR** key is lit, indicating that the signal is connected.
- Alter the voltage setting for the signal so it matches the amplitude value recommended by your oscilloscope manufacturer for calibrating the edge response.

The default setting is 25 mV @ 1 MHz.

3. For example, on a Fluke PM3392A oscilloscope, start with a signal of 1 V @ 1 MHz.
4. Adjust the scale on your oscilloscope to achieve a good picture of the edge. For example, on a Fluke PM3392A oscilloscope with a 1 V @ 1 MHz signal, use 200 mV/div.
5. Adjust the time base on your oscilloscope to the fastest position available (20.0 or 50.0 ns/div).

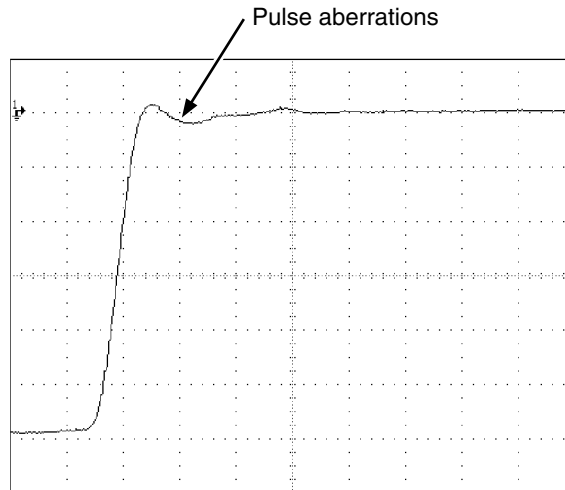

g1007i.eps

6. Verify that your oscilloscope exhibits the proper rise time and pulse aberration characteristics.
7. Remove the input signal by pressing .

The Leveled Sine Wave Function

The Leveled Sine Wave (Levsine) function uses a leveled sine wave, whose amplitude remains relatively constant over a range of frequencies, to check the oscilloscope's bandwidth. When you check your oscilloscope, you change the wave's frequency until the amplitude displayed on the oscilloscope drops 30 %, which is the amplitude that corresponds to the -3 dB point.

To access the Levsine menu, press the softkey under MODE until "levsine" appears.

Note

Make sure there is no cable connected to TRIG OUT while using the Levsine function.

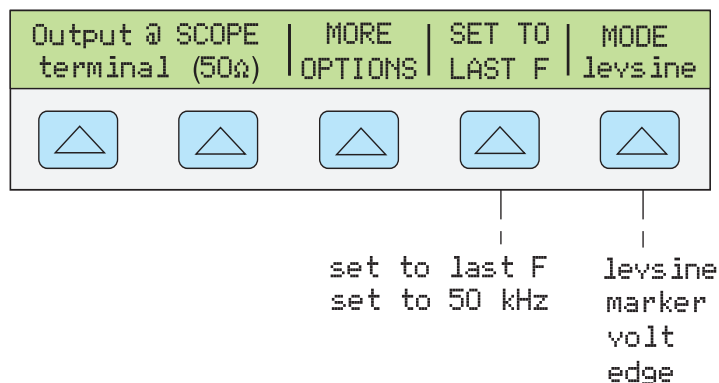

gjm006.eps

Each option in the Levsine menu is described below.

- **OUTPUT @ SCOPE terminal (50Ω)** Indicates the location and impedance of the signal output. If the signal does not appear on the oscilloscope, press **[OPR]**. To disconnect the signal, press **[STBY]**. You cannot change the impedance while you are in Levsine mode.
- **MORE OPTIONS** Opens additional menu items, which are described in detail under “The MORE OPTIONS Menu.”
- **SET TO LAST F** Toggles between the current frequency setting and the reference value of 50 kHz. This option is useful for reverting to the reference to check the output after you make adjustments at another frequency.
- **MODE** Indicates you are in Levsine mode. Use the softkey to change modes and open the corresponding menus for the other three calibration modes.

Shortcuts for Setting the Frequency and Voltage

Three options are available for controlling the sine wave settings.

- **SET TO LAST F** toggles between the last frequency used and the reference frequency of 50 kHz, letting you check the output at the reference after you make adjustments at a different frequency.
- **MORE OPTIONS** lets you use an automatic frequency sweep and lock the voltage range, if necessary. The following section provides details on this menu.
- The **[x10]** and **[+10]** keys step frequencies up or down in amounts that let you quickly access a new set of frequencies. For example, if the value is 250 kHz, **[x10]** changes it to 300 kHz, and **[+10]** changes it to 200 kHz. For voltage values, **[x10]** and **[+10]** step through cardinal point values in a 1.2-3-6 sequence.

The MORE Options Menu

When you select MORE OPTIONS, you open options that give you more control over the frequency and voltage. To access the MORE OPTIONS menu, press the softkey under MORE OPTIONS in the Levsine menu.

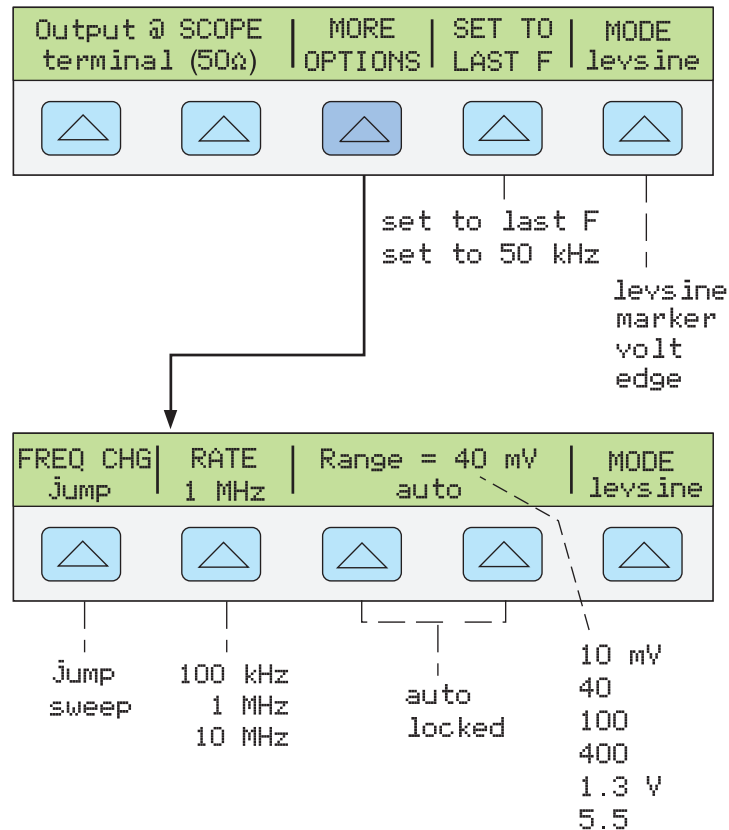

gjm007.eps

Each option in the MORE OPTIONS menu is described below.

- FREQ CHANGE** Toggles between two settings that control the way the output signal adjusts to a new frequency. This is the default setting.

“Jump” causes the output signal to jump immediately to a new frequency setting. “Sweep” causes the signal to sweep through a series of frequency values, over a range you set. Use the sweep function to watch the signal gradually change over a given bandwidth and see the point at which its amplitude changes. Details for using the sweep function are provided under “Sweeping Through a Frequency Range.”
- RATE** Used when FREQ CHANGE is set to “sweep” to toggle the sweep speed among 100 kHz, 1 MHz, and 10 MHz.

The slow sweep rate lets you watch the frequency change very slowly. After a fast sweep, you may want to pinpoint a certain frequency with a slow sweep over a subset of your previous frequency range.
- RANGE** The softkeys toggle between two settings: “auto,” which adjusts the range limit automatically in accordance with the voltage level, and “locked,” which sets the available voltages to one range.

There are six range limits in Levsine mode: 10 mV, 40 mV, 100 mV, 400 mV, 1.3 V, and 5.5 V. When set to “auto” the calibrator uses your voltage setting to automatically set the range limit that provides the most accurate output. When set to “locked” the range limit remains fixed and you can decrease the voltage down to 0 V within any range limit.

For example, assume the range limit is 40 mV. If you set the 40 mV range to “auto” and then enter 1 mV, the calibrator will adjust the range limit to 10 mV and will output 1 mV from within the 10 mV range. If you set the 40 mV range to “locked”

and then enter 1 mV, the calibrator will output 1 mV from within the 40 mV range.

The default range setting is “auto,” which should always be used unless you are troubleshooting discontinuities in your oscilloscope’s vertical gain. The range setting will always return to “auto” after you leave Levsine mode.

Sweeping through a Frequency Range

When you change frequencies using the sweep method, the output sine wave sweeps through a specified range of frequencies, letting you identify the frequency at which the oscilloscope’s signal exhibits certain behavior (e.g., changes amplitude). Before you start this procedure, make sure you are in the MORE OPTIONS menu and the sine wave is displayed on the oscilloscope.

Perform the following procedure to sweep through frequencies.

1. Make sure the output signal shows the starting frequency. If not, key in the starting frequency; then press **ENTER**.
2. Toggle **FREQ CHANGE** to “sweep.” Toggle the **RATE** to “100 kHz” if you want to observe a very slow sweep over a small range.
3. Key in the end frequency; then press **ENTER**.

After you press **ENTER**, the signal sweeps through frequencies between the two values you entered, and the Sweep menu appears on the Control Display as shown below.

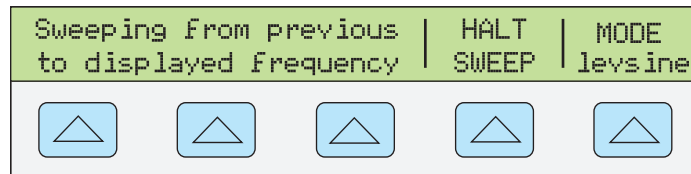

g1031i.eps

4. You can let the signal sweep through the entire range, or you can halt the sweep if you need to record the frequency at a certain point.

To interrupt the sweep, press the softkey under **HALT SWEEP**. The current frequency will appear on the Output Display and the **MORE OPTIONS** menu will reappear on the Control Display.

Note

*When you interrupt the frequency sweep by pressing **HALT SWEEP**, the **FREQ CHANGE** method switches back to “jump”.*

5. Repeat the procedure if necessary. For example, if you did a fast sweep, you may want to pinpoint a certain frequency with a slow sweep over a subset of your previous frequency range.

Frequency Response Calibration Procedure for an Oscilloscope

This sample procedure, which verifies the frequency response on your oscilloscope, is usually performed after the pulse response is verified.

This procedure checks the bandwidth by finding the frequency at the -3 dB point for your oscilloscope. The reference sine wave in this procedure has an amplitude of 6 divisions, so that the -3 dB point can be found when the amplitude drops to 4.2 divisions.

Before you start this example procedure, verify that you are running the oscilloscope option in Levsine mode. If you are, the Control Display shows the following menu.

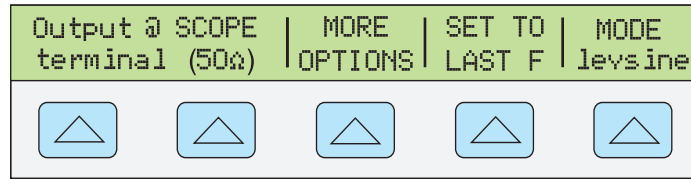

gl032i.eps

Perform the following sample procedure to calibrate the frequency response.

1. Reconnect the signal by pressing the key on the 5080A. Select 50 Ω impedance or use a 50 Ω external termination directly at the oscilloscope input.
2. Adjust the sine wave settings in the Output Display according to the calibration recommendations in your oscilloscope manual. For example, for the Fluke PM3392A oscilloscope, start at 120 mV @ 50 kHz. To enter 120 mV, press ; then press .
3. Adjust the oscilloscope as necessary. The sine wave should appear at exactly six divisions, p-p, as shown below.

If necessary, make small adjustments to the voltage amplitude until the wave reaches exactly six divisions. To fine-tune the voltage, press to bring a cursor into the Output Display, move the cursor with the key, and turn the rotary knob to adjust the value. (See “Fine-Tuning Values” earlier in this chapter.)

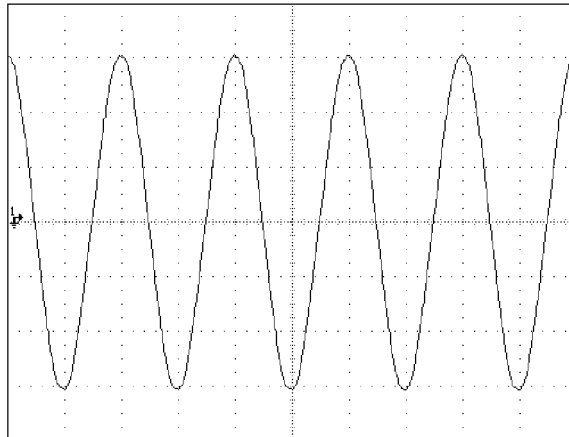

gl009i.bmp

4. Increase the frequency to 60 MHz (for 100 MHz instruments), or 150 MHz (for 200 MHz instruments). To enter 60 MHz, press ; then press .
5. Continue to increase the frequency slowly until the waveform decreases to 4.2 divisions, as shown below.

To increase the frequency slowly, fine-tune it using the rotary knob. To do this, press to place a cursor in the Output Display. Press again to place it in the frequency field, and use the and keys to move it to the digit you want to change. Then change the value by turning the rotary knob.

Continue making small increments in the frequency until the signal drops to 4.2 divisions. At 4.2 divisions, the signal is at the frequency that corresponds to the -3 dB point.

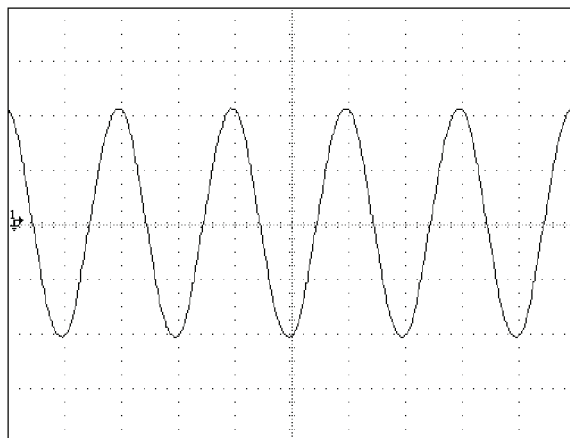

gl010i.bmp

6. Remove the input signal by pressing **STBY**.
7. Repeat this procedure for the remaining channels on your oscilloscope.

Calibrating the Time Base of an Oscilloscope

The horizontal deflection (time base) of an oscilloscope is calibrated using a method similar to the vertical gain calibration. A time marker signal is generated from the 5080A and the signal's peaks are matched to the graticule line divisions on the oscilloscope.

The Time Marker Function

The Time Marker function, which is available through the Marker menu, lets you calibrate the timing response of your oscilloscope. To access the Marker menu, press the softkey under MODE until "marker" appears.

Output at SCOPE terminal (50 Ω)	SHAPE	TRIG	MODE
terminal (50 Ω)	spike	off	marker
	spike	off	marker
	square	/1	volt
	sq20%	/10	edge
	sine	/100	levsine

gjm008.eps

Each option in the Marker menu is described below.

- **OUTPUT @ SCOPE terminal** Indicates the location of the signal output. If the signal does not appear on the oscilloscope, press **OPR**. To disconnect the signal, press **STBY**.
- **SHAPE** Indicates the type of waveform. Depending on frequency setting, possible selections are sine, spike, square (50 % duty cycle square wave), and sq20% (20 % duty cycle square wave.) Note that selections available under SHAPE depend on the selected marker period (frequency), shown in Table 1.

Table 1. Shape Marker Periods

Selection	Period (Frequency)
sine	10 ns – 2 ns (100 MHz – 500 MHz)
spike	5 s – 20 ns (0.2 Hz – 50 MHz)
square	5 s – 10 ns (0.2 Hz – 100 MHz)
sq20%	20 ms – 100 ns (50 kHz – 10 MHz)

- **TRIG** If you are using the external trigger, use this key to cycle through the trigger settings. The available trigger settings are: off, /1 (trigger signal appears on each marker), /10 (trigger signal appears on every tenth marker), and /100 (trigger signal appears at every 100th marker).
- **MODE** Indicates you are in Marker mode. Use the softkey to change modes and open the corresponding menus for the other three oscilloscope calibration modes.

Default marker values are 1.000 ms, SHAPE = spike.

The $\times 10$ and $\div 10$ keys step the voltages through cardinal point values of an oscilloscope in a 1-2-5 step sequence. For example, if the period is 1.000 ms, pressing $\times 10$ increases the period to the nearest cardinal point, which is 2.000 ms. Pressing $\div 10$ decreases the voltage to the nearest cardinal point, which is 500 μ s.

Time Base Marker Calibration Procedure for an Oscilloscope

This sample procedure uses the Time Marker function to check the horizontal deflection (time base) of your oscilloscope. See your oscilloscope's manual for the exact time base values recommended for calibration.

Before you begin this procedure, verify that you are in Marker mode. If you are, the Control Display shows the following menu.

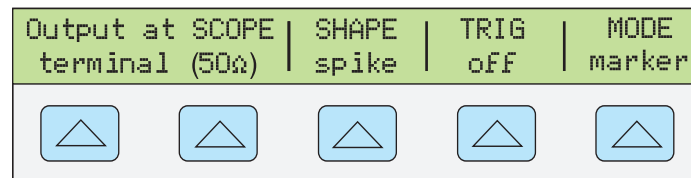

gjm009.eps

Perform the following sample procedure to calibrate the time base.

1. Connect the calibrator to Channel 1 on the oscilloscope. Select 50 Ω impedance or use an external 50 Ω termination. Make sure the oscilloscope is dc-coupled.
2. Apply a time marker value according to the recommended calibration settings in your oscilloscope manual. For example, to enter 200 ns, press $2 \ 0 \ 0 \ \text{SHIFT} \ k \ \text{SHIFT} \ Hz$, then press ENTER .

Note

*You may enter the equivalent frequency instead of the time marker value.
For example, instead of entering 200 ns, you may enter 5 MHz.*

3. Set your oscilloscope's time base to show 10 time markers. The time markers should align with the oscilloscope divisions, as shown in the example below. For an accurate reading, align the signal's peaks with the horizontal center axis.

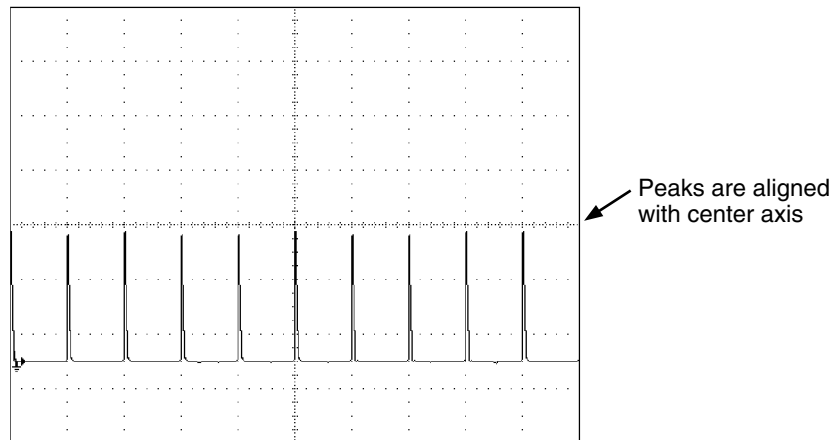

gl011i.eps

4. Repeat this procedure for all time marker values recommended for your oscilloscope. Repeat for digital and analog mode as required. Some oscilloscopes may need the magnification changed while calibrating in analog mode.
5. Remove the signal by pressing .

Summary of Commands and Queries

This section describes commands and queries that are used specifically for the oscilloscope calibration option. Each command falls into one or more command categories: Sequential, Overlapped, or Coupled.

Sequential Commands – Commands executed immediately as they are encountered in the data stream are called sequential commands. For more information, see “Sequential Commands” in Chapter 5 of the 5080A Operators Manual.

Overlapped Commands – Commands that require additional time to execute are called overlapped commands because they can overlap the next command before completing execution. To be sure an overlapped command is not interrupted during execution, use the *OPC, *OPC?, and *WAI commands to detect command completion. See Table 6-8 for all the commands that are classified as overlapped. For more information, see “Overlapped Commands” in Chapter 5 of the 5080A Operators Manual.

Coupled Commands – These are called coupled commands (examples: CUR_POST and OUT) because they “couple” in a compound command sequence. Care must be taken to be sure the action of one command does not disable the action of a second command and thereby cause a fault. See Table 6-8 for all the commands that are classified as coupled. For more information, see “Coupled Commands” in Chapter 5 of the 5080A Operators Manual.

Table 2. Overlapped and Coupled Commands

Command	Overlapped	Coupled
SCOPE(?)	Yes	Yes
TRIG(?)	Yes	No
OUT_IMP(?)	Yes	Yes

SCOPE(?) <value >

Description Programs the 5080A to use the Megohm Option, if installed.

Parameters <value> = OFF Turns the Scept option off. Programs 0 V, 0 Hz output at the NORMAL terminals.

VOLT Oscilloscope ac and dc voltage mode. Programs 20 mV p-p, 1 kHz, output at the SCOPE BNC, output impedance 1 MΩ standby if from OFF or previously in standby.

EDGE Oscilloscope edge mode. Programs 25 mV p-p, 1 MHz, output at the SCOPE BNC, standby if from OFF or previously in standby.

LEVSINE Oscilloscope-leveled sine mode. Programs 30 mV p-p, 50 kHz, output at the SCOPE BNC, standby if from OFF or previously in standby.

MARKER Oscilloscope Marker mode. Programs the period to 1 ms, output at the SCOPE BNC, standby if from OFF or previously in standby.

Example SCOPE VOLT; OUT -2 V, 0 Hz (dc voltage, -2 V)
 SCOPE VOLT; OUT 4 V, 1 kHz (ac voltage, 4 V p-p, 1 kHz)
 SCOPE EDGE; OUT 0.5 V, 5 kHz (Edge, 0.5 V p-p, 5 kHz)
 SCOPE LEVSINE; OUT 1 V, 200 kHz (Leveled sinewave, 1 V p-p, 200 kHz)
 SCOPE MARKER; OUT 2 MS (Marker period of 2 ms)

Query SCOPE? Returns the current mode of operation (OFF, VOLT, EDGE, LEVSINE, or MARKER).

TRIG(?) <value >

Description Programs the scope options trigger out BNC.

Parameters <value> = OFF Turns the trigger output off.

DIV1 Turns the trigger output on. Frequency is the same as the signal at SCOPE output.

DIV10 Turns the trigger output on. Frequency is 1/10 the signal at SCOPE output.

DIV100 Turns the trigger output on. Frequency is 1/100 the signal at SCOPE output.

Example TRIG OFF Turns the trigger output off.

Query TRIG? Returns the mode of the Megohm option (OFF, DIV1, DIV10, or DIV100).

OUT_IMP(?) <value >

Description	Programs the scope options output impedance.		
Parameters	<value> = Z50		Programs the oscilloscope option's output to 50 Ω.
	Z1M		Programs the oscilloscope option's output to 1 MΩ
Example	OUT_IMP Z1M		Sets the scope options output impedance to 1 MΩ.
Query	OUT_IMP?		Returns the scope options output impedance (Z50 or Z1M).

Verification Tables

Before the 5080A/SC Option leaves the Fluke factory, it is verified to meet its specifications at the following test points. The verification test points are provided here as a guide when re-verification is desired.

Table 3. Voltage Function Verification: AC Voltage into a 1 MΩ ohm Load

Nominal Value (p-p)	Frequency	Measured Value (p-p)	Deviation (mV)	1-Year Spec. (mV)
5.0 mV	45 Hz			0.2175
5.0 mV	100 Hz			0.2175
5.0 mV	1 kHz			0.2175
10.0 mV	1 kHz			0.235
20.0 mV	100 Hz			0.27
20.0 mV	1 kHz			0.27
50.0 mV	1 kHz			0.375
89.0 mV	1 Hz			0.5115
89.0 mV	45 Hz			0.5115
100.0 mV	1 kHz			0.55
200.0 mV	100 Hz			0.90
200.0 mV	1 kHz			0.90
500.0 mV	1 kHz			1.95
890.0 mV	45 Hz			3.215
890.0 mV	1 kHz			3.215
1.0 V	100 Hz			3.7
1.0 V	1 kHz			3.7
2.0 V	1 kHz			7.2
5.0 V	45 Hz			17.7
5.0 V	1 kHz			17.7
10.0 V	1 kHz			35.2

Table 3. Voltage Function Verification: AC Voltage into a 1 MΩ ohm Load (cont.)

Nominal Value (p-p)	Frequency	Measured Value (p-p)	Deviation (mV)	1-Year Spec. (mV)
20.0 V	1 kHz			70.2
50.0 V	45 Hz			175.2
50.0 V	100 Hz			175.2
50.0 V	1 kHz			175.2
105.0 V	100 Hz			6050
105.0 V	1 kHz			6050

Table 4. Voltage Function Verification: AC Voltage into a 50 Ω Load

Nominal Value (p-p)	Frequency	Measured Value (p-p)	Deviation (mV)	1-Year Spec. (mV)
5.0 mV	45 Hz			0.2175
5.0 mV	100 Hz			0.2175
5.0 mV	1 kHz			0.2175
10.0 mV	100 Hz			0.235
10.0 mV	1 kHz			0.235
20.0 mV	1 kHz			0.375
44.9 mV	45 Hz			0.35715
44.9 mV	1 kHz			0.35715
50.0 mV	1 kHz			0.375
100.0 mV	100 Hz			0.55
100.0 mV	1 kHz			0.55
200.0 mV	1 kHz			0.9
449.0 mV	45 Hz			0.7715
449.0 mV	1 kHz			0.7715
500.0 mV	1 kHz			1.95
1.0 V	100 Hz			3.7
1.0 V	1 kHz			3.7
2.0 V	45 Hz			7.2
2.0 V	100 Hz			7.2
2.0 V	1 kHz			7.2

Table 5. Voltage Function Verification: DC Voltage into a 50 Ω Load

Nominal Value (dc)	Measured Value (dc)	Deviation (mV)	1-Year Spec. (mV)
0.0 mV			0.2
5.0 mV			0.2175
-5.0 mV			0.2175
10.0 mV			0.235
-10.0 mV			0.235
22.0 mV			0.277
-22.0 mV			0.277
25.0 mV			0.2875
-25.0 mV			0.2875
55.0 mV			0.3925
-55.0 mV			0.3925
100.0 mV			0.55
-100.0 mV			0.55
220.0 mV			0.97
-220.0 mV			0.97
250.0 mV			1.075
-250.0 mV			1.075
550.0 mV			2.125
-550.0 mV			2.125
700.0 mV			2.65
-700.0 mV			2.65
2.2 V			7.9
-2.2 V			7.9

Table 6. Voltage Function Verification: DC Voltage into a 1 M Ω Load

Nominal Value (dc)	Measured Value (dc)	Deviation (mV)	1-Year Spec. (mV)
0.0 mV			0.2
5.0 mV			0.2175
-5.0 mV			0.2175
22.0 mV			0.277
-22.0 mV			0.277
25.0 mV			0.2875
-25.0 mV			0.2875

Table . Voltage Function Verification: DC Voltage into a 1 MΩ Load (cont.)

Nominal Value (dc)	Measured Value (dc)	Deviation (mV)	1-Year Spec. (mV)
45.0 mV			0.3575
-45.0 mV			0.3575
50.0 mV			0.37
-50.0 mV			0.37
220.0 mV			0.97
-220.0 mV			0.97
250.0 mV			1.075
-250.0 mV			1.075
450.0 mV			1.775
-450.0 mV			1.775
500.0 mV			1.95
-500.0 mV			1.95
3.3 V			11.75
-3.3 V			11.75
4.0 V			14.2
-4.0 V			14.2
33.0 V			115.7
-33.0 V			115.7

Table 7. Edge Function Verification

Nominal Value (p-p)	Frequency	Pulse Response Time (nS)	1-Year Spec. (ns)
250.0 mV	1 MHz		1
250.0 mV	1 MHz		1
250.0 mV	10 kHz		1
250.0 mV	100 kHz		1
250.0 mV	1 MHz		1
2.5 V	1 MHz		1

Table 8. Leveled Sine Wave Function Verification: Amplitude

Nominal Value (p-p)	Frequency	Measured Value (p-p)	Deviation (mV)	1-Year Spec. (mV)
5.0 mV	50 kHz			0.300
10.0 mV	50 kHz			0.400
20.0 mV	50 kHz			0.600

Table 8. Levelled Sine Wave Function Verification: Amplitude (cont.)

Nominal Value (p-p)	Frequency	Measured Value (p-p)	Deviation (mV)	1-Year Spec. (mV)
40.0 mV	50 kHz			1.000
50.0 mV	50 kHz			1.200
100.0 mV	50 kHz			2.200
200.0 mV	50 kHz			4.200
400.0 mV	50 kHz			8.200
500.0 mV	50 kHz			10.200
1.3 V	50 kHz			26.200
2.0 V	50 kHz			40.200
5.5 V	50 kHz			110.200

Table 9. Levelled Sine Wave Function Verification: Flatness

Nominal Value (p-p)	Frequency	Measured Value (p-p)	Deviation (mV)	1-Year Spec. (mV)
5.0 mV	500 kHz			0.18
5.0 mV	1 MHz			0.18
5.0 mV	1 MHz			0.18
5.0 mV	2 MHz			0.18
5.0 mV	5 MHz			0.18
5.0 mV	10 MHz			0.18
5.0 mV	20 MHz			0.18
5.0 mV	50 MHz			0.18
5.0 mV	100 MHz			0.18
5.0 mV	125 MHz			0.20
5.0 mV	160 MHz			0.20
5.0 mV	200 MHz			0.20
10.0 mV	500 kHz			0.25
10.0 mV	1 MHz			0.25
10.0 mV	1 MHz			0.25
10.0 mV	2 MHz			0.25
10.0 mV	5 MHz			0.25
10.0 mV	10 MHz			0.25
10.0 mV	20 MHz			0.25
10.0 mV	50 MHz			0.25

Table 9. Leveled Sine Wave Function Verification: Flatness (cont.)

Nominal Value (p-p)	Frequency	Measured Value (p-p)	Deviation (mV)	1-Year Spec. (mV)
10.0 mV	100 MHz			0.25
10.0 mV	125 MHz			0.30
10.0 mV	160 MHz			0.30
10.0 mV	200 MHz			0.30
40.0 mV	500 kHz			0.70
40.0 mV	1 MHz			0.70
40.0 mV	1 MHz			0.70
40.0 mV	2 MHz			0.70
40.0 mV	5 MHz			0.70
40.0 mV	10 MHz			0.70
40.0 mV	20 MHz			0.70
40.0 mV	50 MHz			0.70
40.0 mV	100 MHz			0.70
40.0 mV	125 MHz			0.90
40.0 mV	160 MHz			0.90
40.0 mV	200 MHz			0.90
40.0 mV	220 MHz			0.90
40.0 mV	235 MHz			0.90
40.0 mV	250 MHz			0.90
100.0 mV	500 kHz			1.60
100.0 mV	1 MHz			1.60
100.0 mV	1 MHz			1.60
100.0 mV	2 MHz			1.60
100.0 mV	5 MHz			1.60
100.0 mV	10 MHz			1.60
100.0 mV	20 MHz			1.60
100.0 mV	50 MHz			1.60
100.0 mV	100 MHz			1.60
100.0 mV	125 MHz			2.10
100.0 mV	160 MHz			2.10
100.0 mV	200 MHz			2.10
400.0 mV	500 kHz			6.10

Table 9. Leveled Sine Wave Function Verification: Flatness (cont.)

Nominal Value (p-p)	Frequency	Measured Value (p-p)	Deviation (mV)	1-Year Spec. (mV)
400.0 mV	1 MHz			6.10
400.0 mV	1 MHz			6.10
400.0 mV	2 MHz			6.10
400.0 mV	5 MHz			6.10
400.0 mV	10 MHz			6.10
400.0 mV	20 MHz			6.10
400.0 mV	50 MHz			6.10
400.0 mV	100 MHz			6.10
400.0 mV	125 MHz			8.10
400.0 mV	160 MHz			8.10
400.0 mV	200 MHz			8.10
1.3 V	500 kHz			19.60
1.3 V	1 MHz			19.60
1.3 V	1 MHz			19.60
1.3 V	2 MHz			19.60
1.3 V	5 MHz			19.60
1.3 V	10 MHz			19.60
1.3 V	20 MHz			19.60
1.3 V	50 MHz			19.60
1.3 V	100 MHz			19.60
1.3 V	125 MHz			26.10
1.3 V	160 MHz			26.10
1.3 V	200 MHz			26.10
5.5 V	500 kHz			82.6
5.5 V	1 MHz			82.6
5.5 V	1 MHz			82.6
5.5 V	2 MHz			82.6
5.5 V	5 MHz			82.6
5.5 V	10 MHz			82.6
5.5 V	20 MHz			82.6
5.5 V	50 MHz			82.6
5.5 V	100 MHz			82.6
5.5 V	125 MHz			110.10

Table 9. Levelled Sine Wave Function Verification: Flatness (cont.)

Nominal Value (p-p)	Frequency	Measured Value (p-p)	Deviation (mV)	1-Year Spec. (mV)
5.5 V	160 MHz			110.10
5.5 V	200 MHz			110.10

Table 10. Levelled Sine Wave Function Verification: Frequency

Nominal Value (p-p)	Frequency	Measured Frequency	Deviation	1-Year Spec.
1.3 V	50 kHz			0.0013 kHz
1.3 V	10 MHz			0.0003 MHz
1.3 V	200 MHz			0.0050 MHz

Table 11. Marker Generator Function Verification

Nominal Interval	Measured Interval	Deviation	1-Year Spec.
5 s			25.13 ms
2.00 s			4.05 ms
1 s			1.03 ms
500.00 ms			262.50 ms
200.00 ms			45.00 ms
100.00 ms			12.50 ms
50.00 ms			3.75 ms
20.00 ms			6.50 μs
10.00 ms			1.75 μs
5.00 ms			500.00 ns
2.00 ms			110.00 ns
1.00 ms			40.00 ns
500.00 μs			16.25 ns
200.00 μs			5.600 ns
100.00 μs			2.650 ns
50.00 μs			1.288 ns
20.00 μs			0.506 ns
10.00 μs			0.252 ns
5.00 μs			0.125 ns
2.00 μs			0.050 ns
1.00 μs			0.025 ns
500.00 ns			0.013 ns
200.00 ns			5.001 ps

Table 11. Marker Generator Function Verification (cont.)

Nominal Interval	Measured Interval	Deviation	1-Year Spec.
100.00 ns			2.500 ps
50.00 ns			1.250 ps
20.00 ns			0.500 ps
10.00 ns			0.250 ps
5.00 ns			0.125 ps
2.00 ns			0.050 ps